

# SALTA / SAPPORO

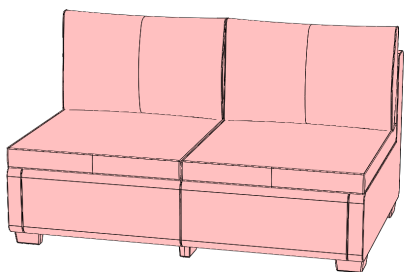

---

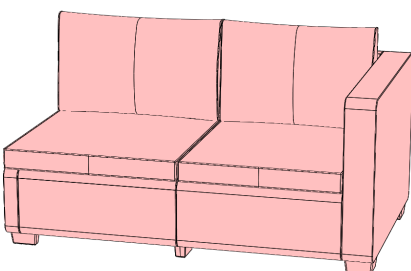

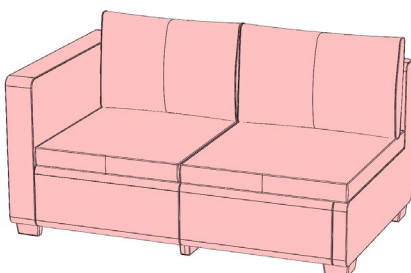
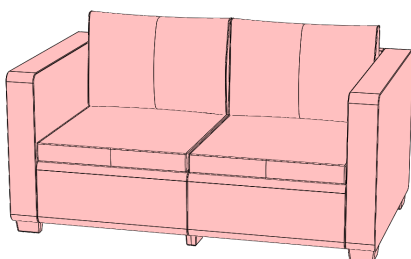

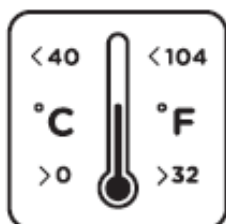

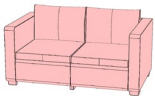

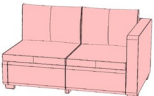
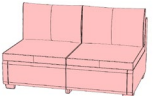
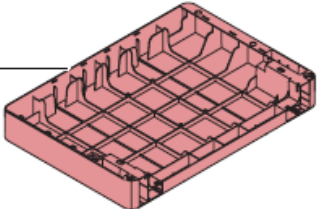
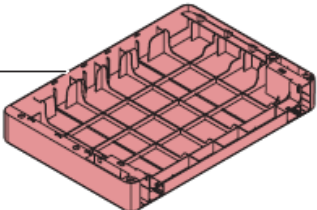
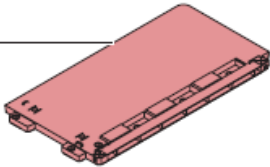
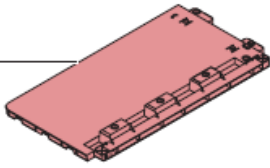
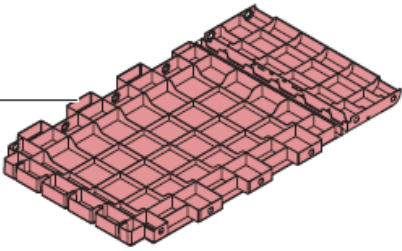
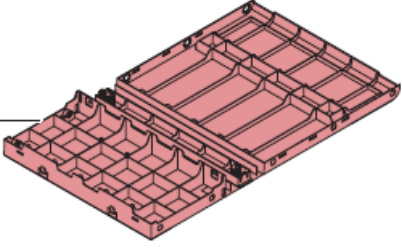
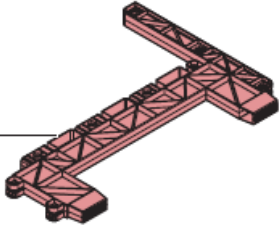
2 SEAT SOFA

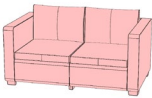

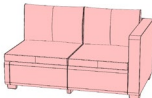
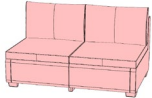
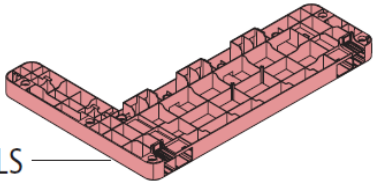
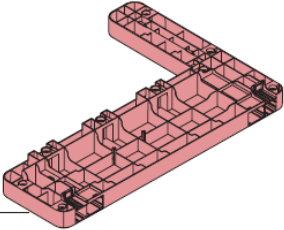
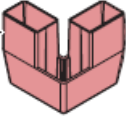

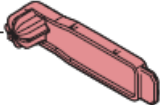
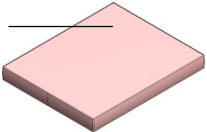

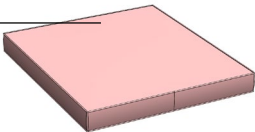
|  |  |  |  |  |
|--|--|--|--|--|
| RS    | 1x   | 1x   | -  | -  |
| LS    | 1x   | -  | 1x   | -  |
| LSC   | 1x   | -  | 1x   | -  |
| RSC  | 1x   | -  | 1x   | -  |
| S   | 2x   | 2x   | 2x   | 2x   |
| B   | 2x   | 2x   | 2x   | 2x   |
| ML  | 1x   | 1x   | 1x   | 1x   |

|  |  |  |  |  |
|--|--|--|--|--|
|  <p>LS</p>  | -  | 1x   | -  | 1x   |
|  <p>RS</p>  | -  | -  | 1x   | 1x   |
|  <p>L</p>   | 4x   | 4x   | 4x   | 4x   |
|  <p>M</p>  | 33x  | 33x  | 33x  | 33x  |
|  <p>Z</p>   | 1x<br>+2 extra   | 1x<br>+2 extra   | 1x<br>+2 extra   | 1x<br>+2 extra   |
|  <p>SCA</p> <p>Seat cushion A<br/>72x59 cm<br/>28x23 in</p>     | 2x   | 1x   | 1x   | -  |
|  <p>BCA</p> <p>Back cushion A<br/>50x65 cm<br/>19,5x25,5 in</p> | 2x   | 1x   | 1x   | -  |
|  <p>SCB</p> <p>Seat cushion B<br/>72x65 cm<br/>28x25,5 in</p>   | -  | 1x   | 1x   | 2x   |
|  <p>BCB</p> <p>Back cushion B<br/>50x71 cm<br/>19,5x28 in</p>   | -  | 1x   | 1x   | 2x   |

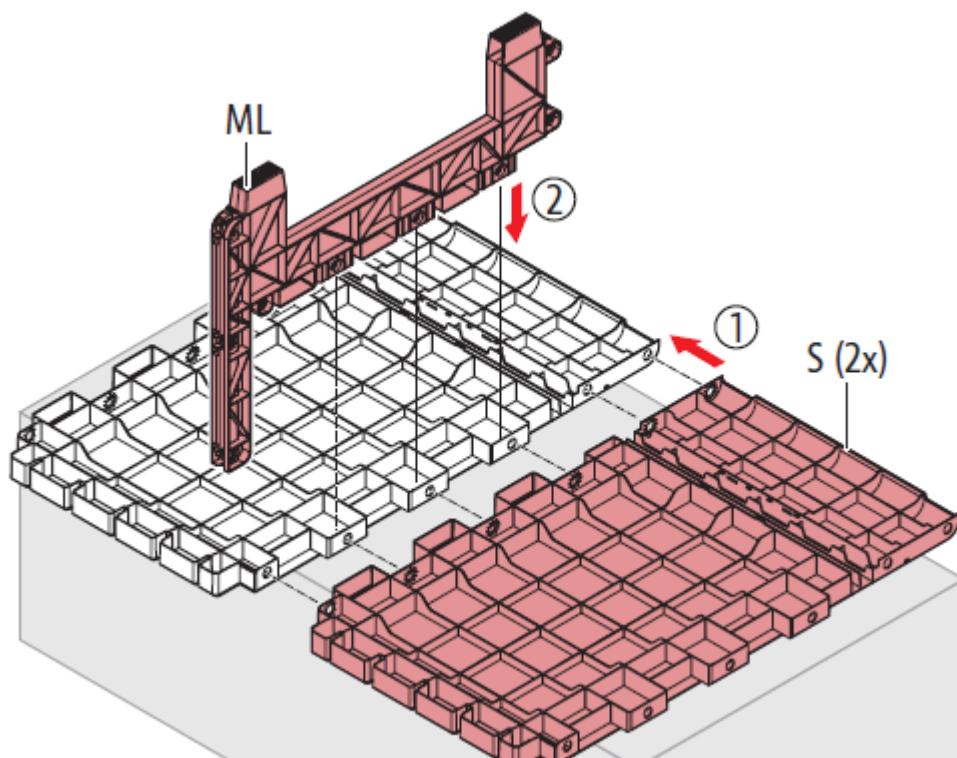

1

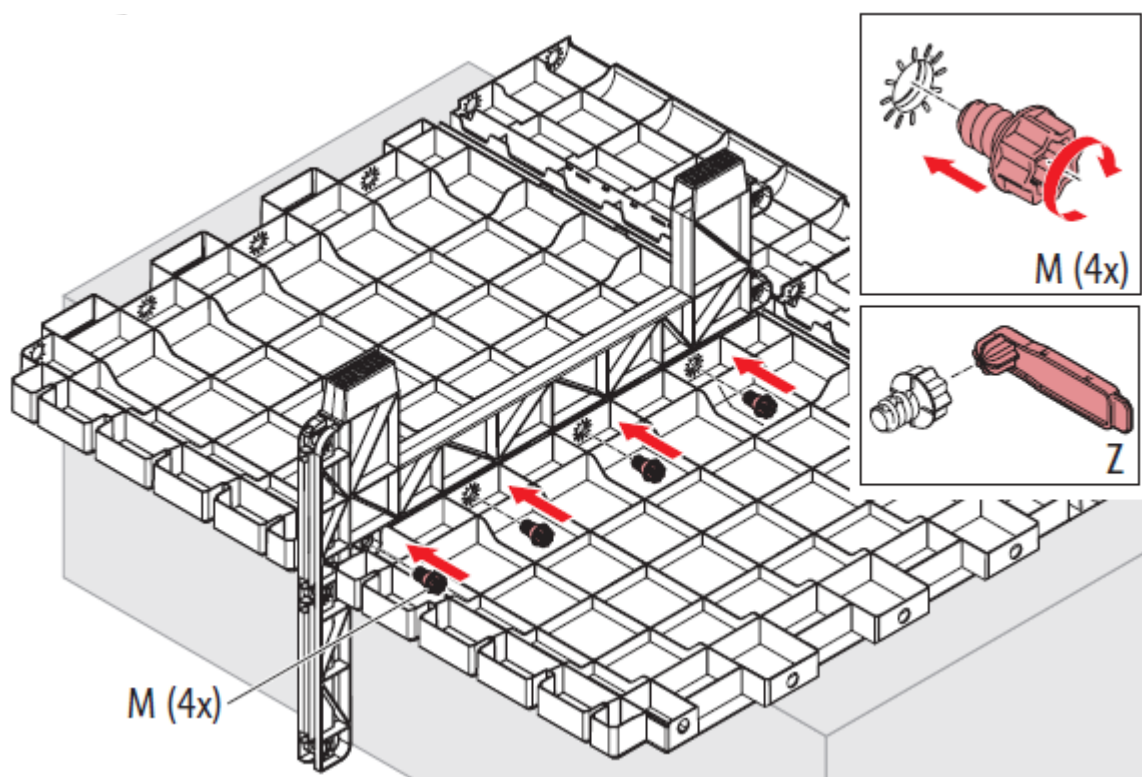

2

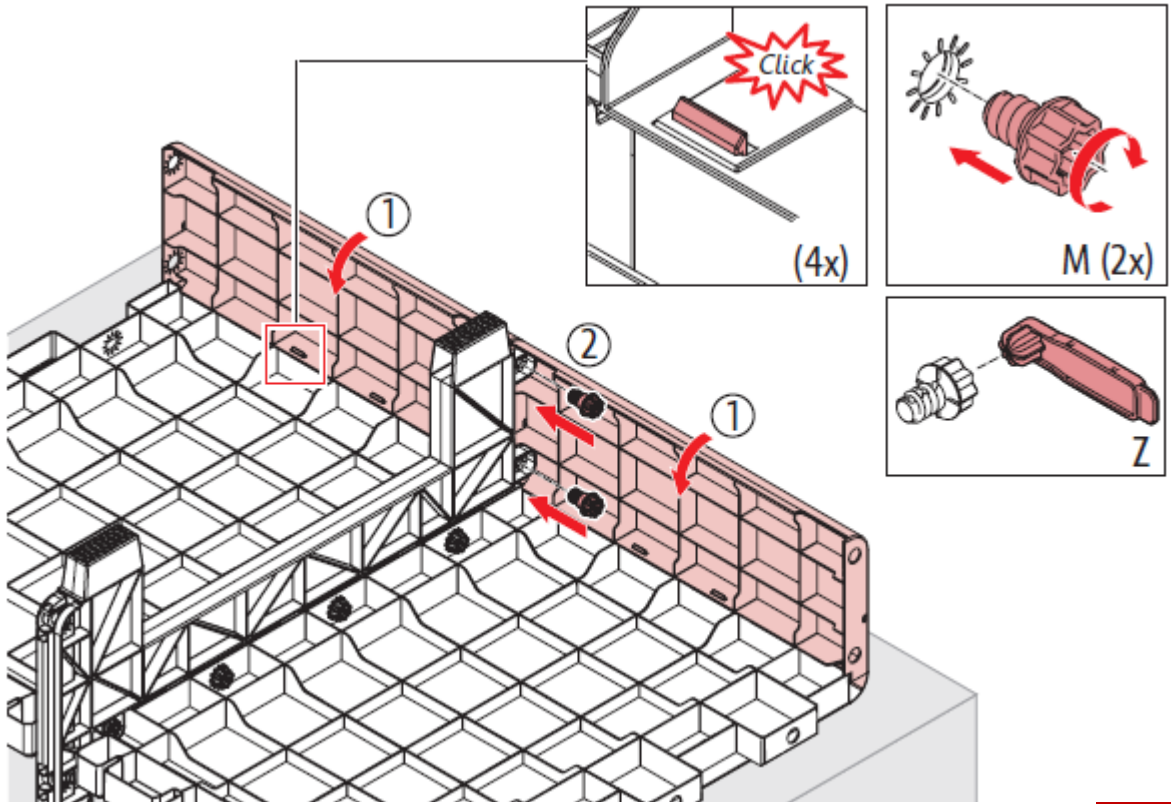

3

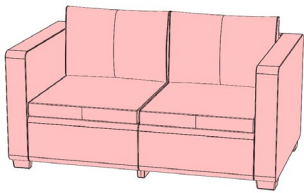

4 — 14

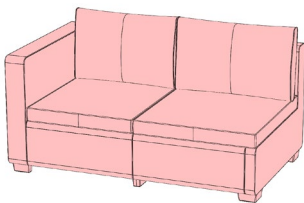

15 — 23

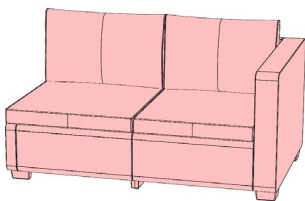

24 — 32

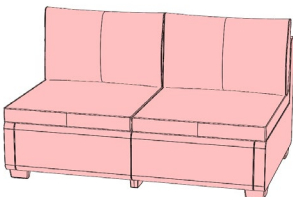

33 — 39



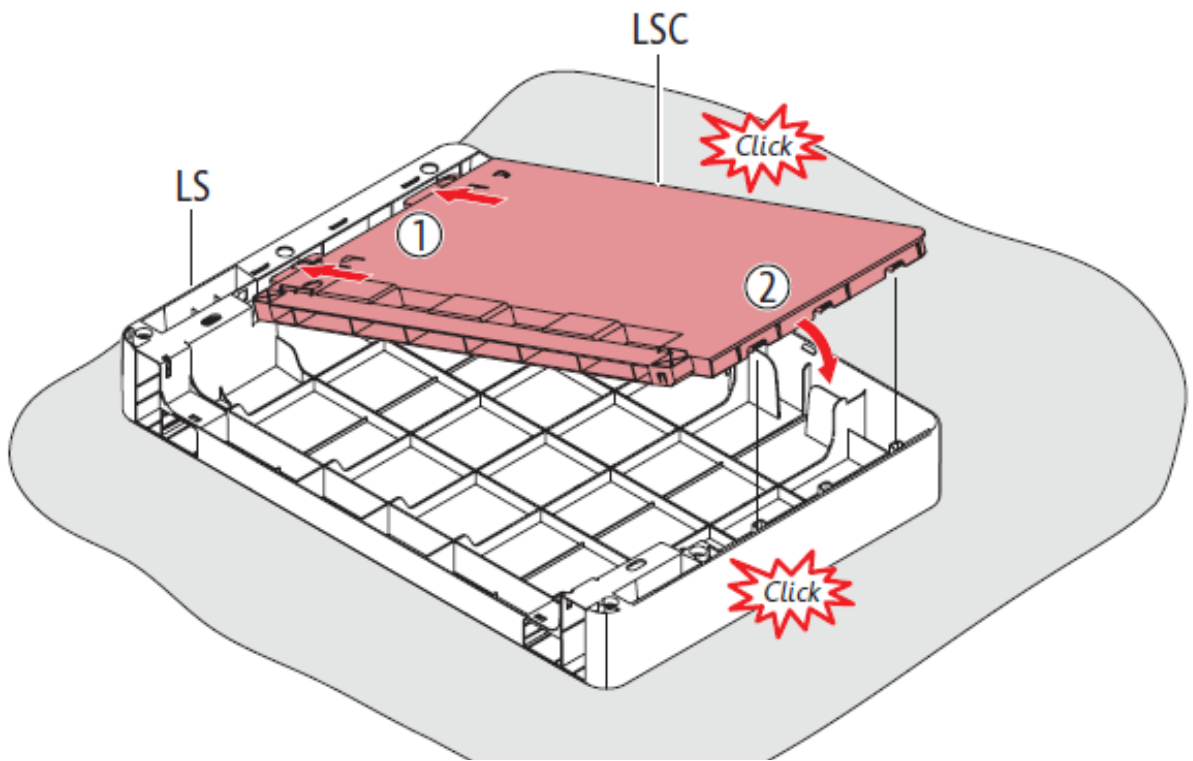

4

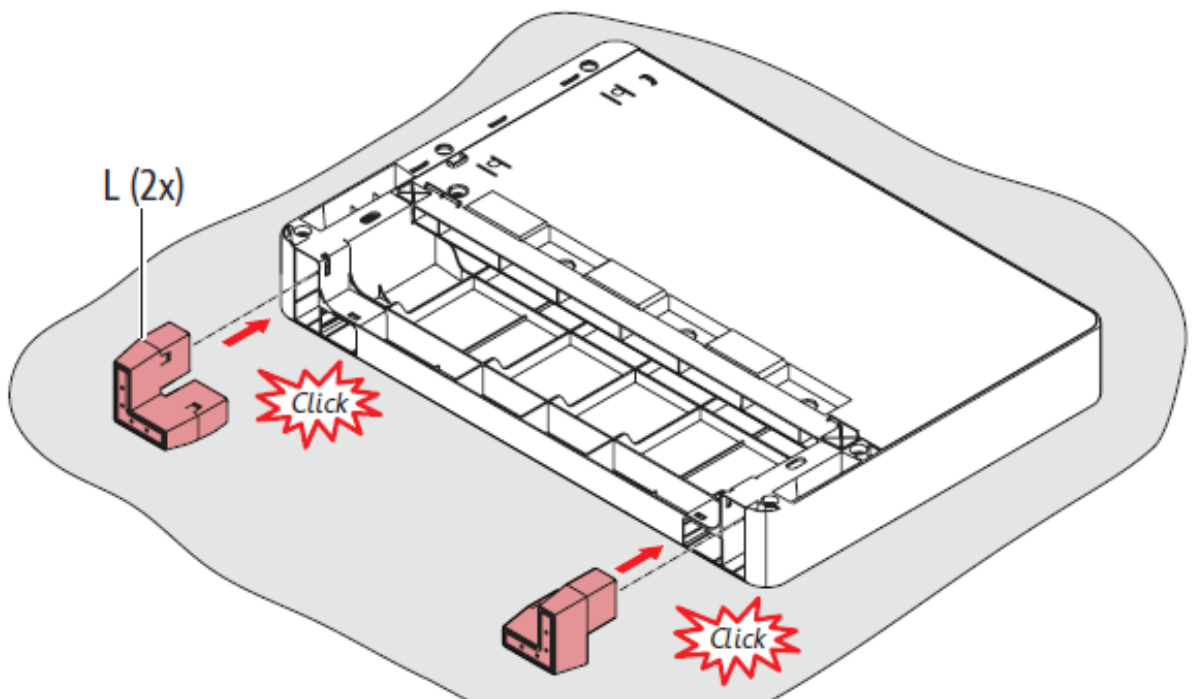

5



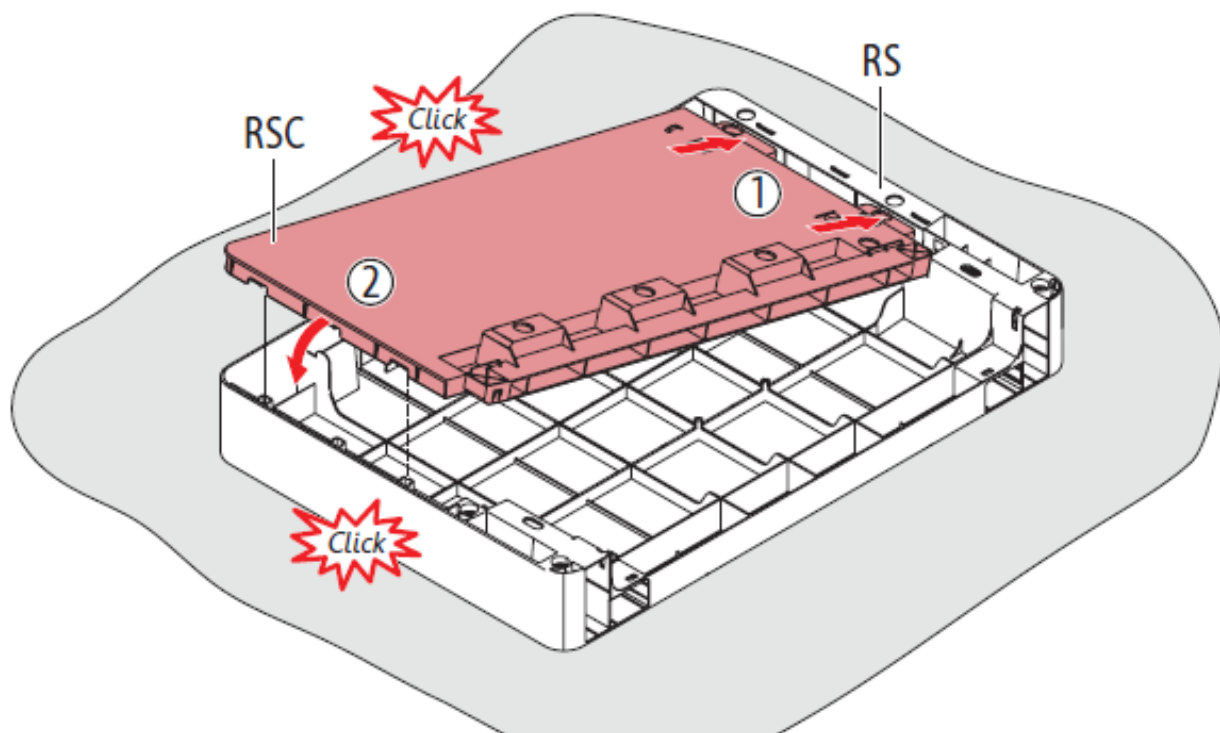

6

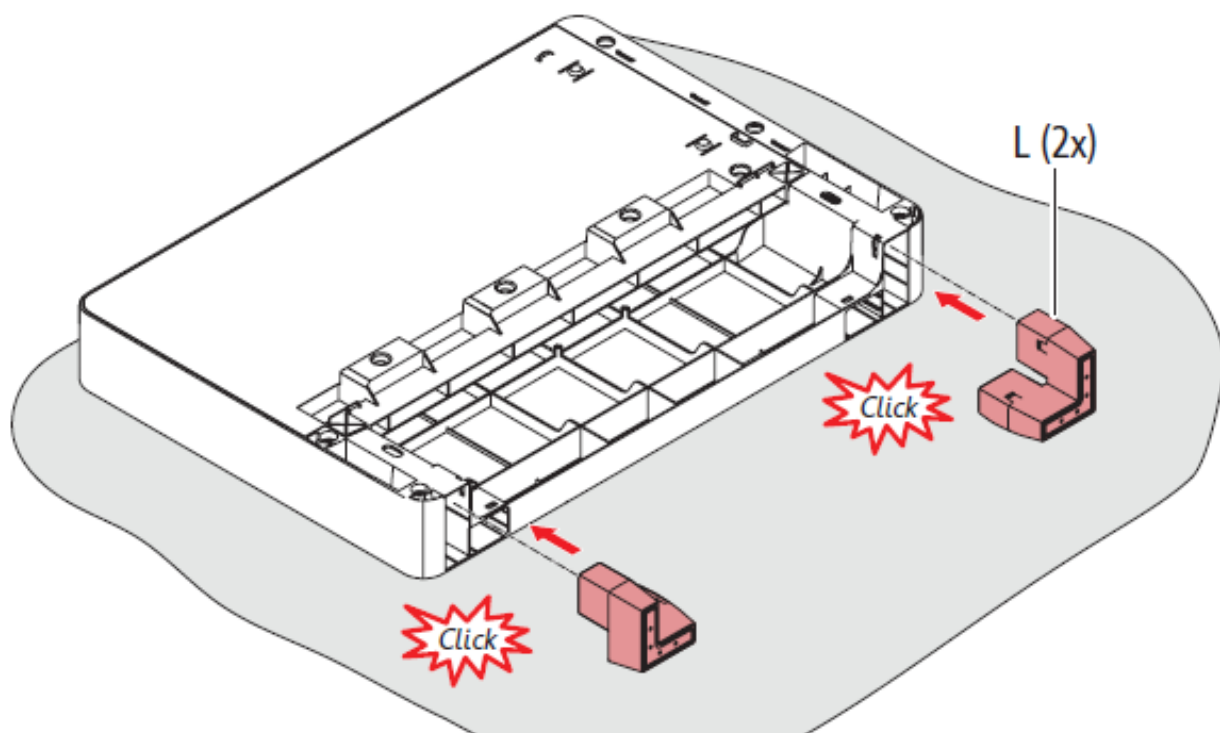

7

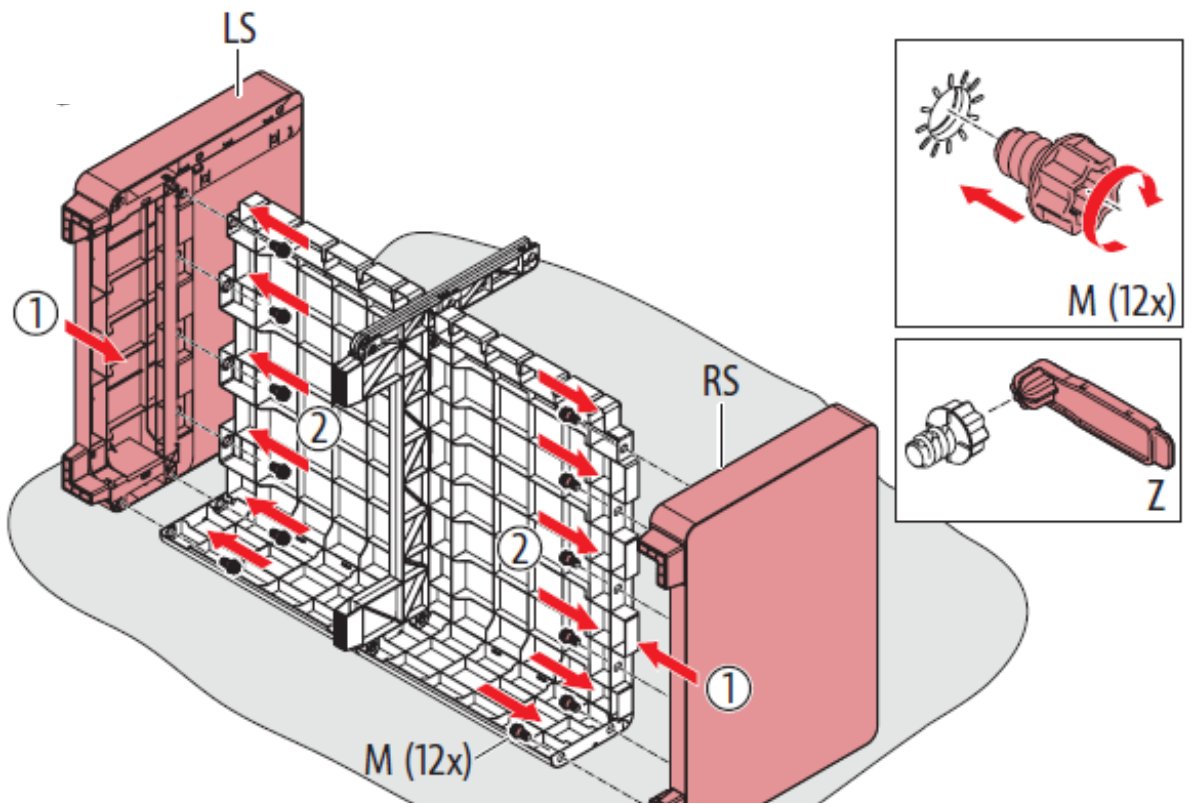

8

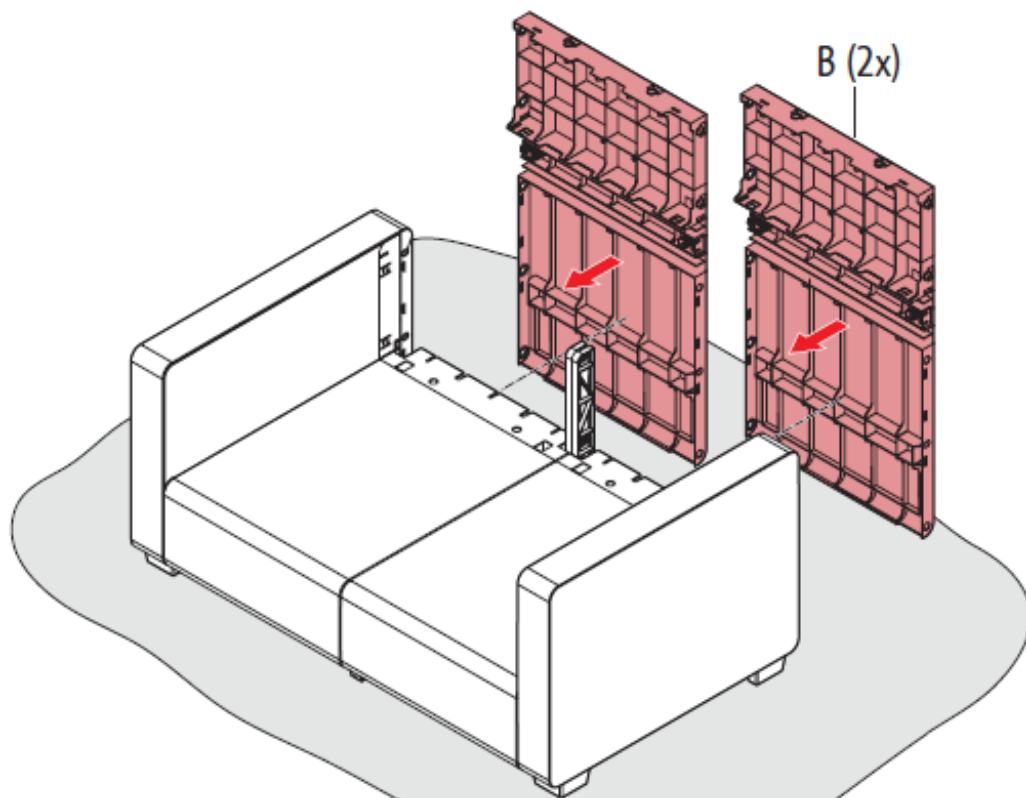

9

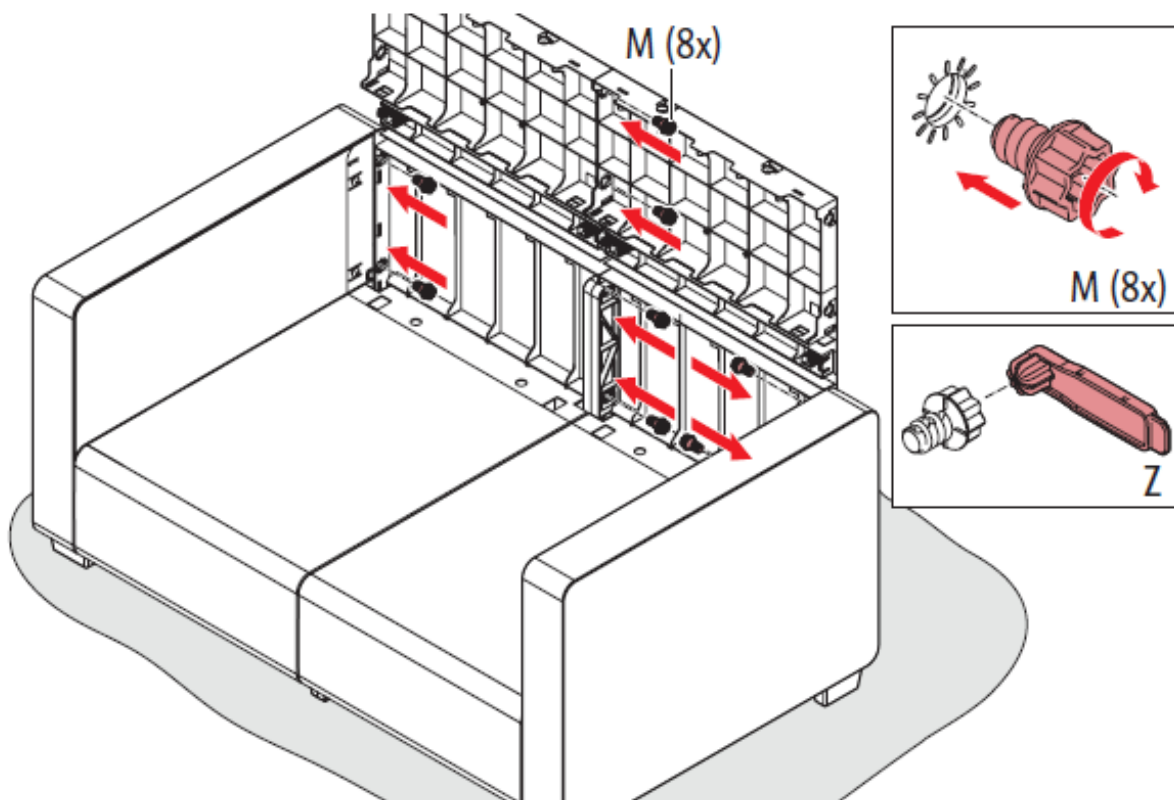

10

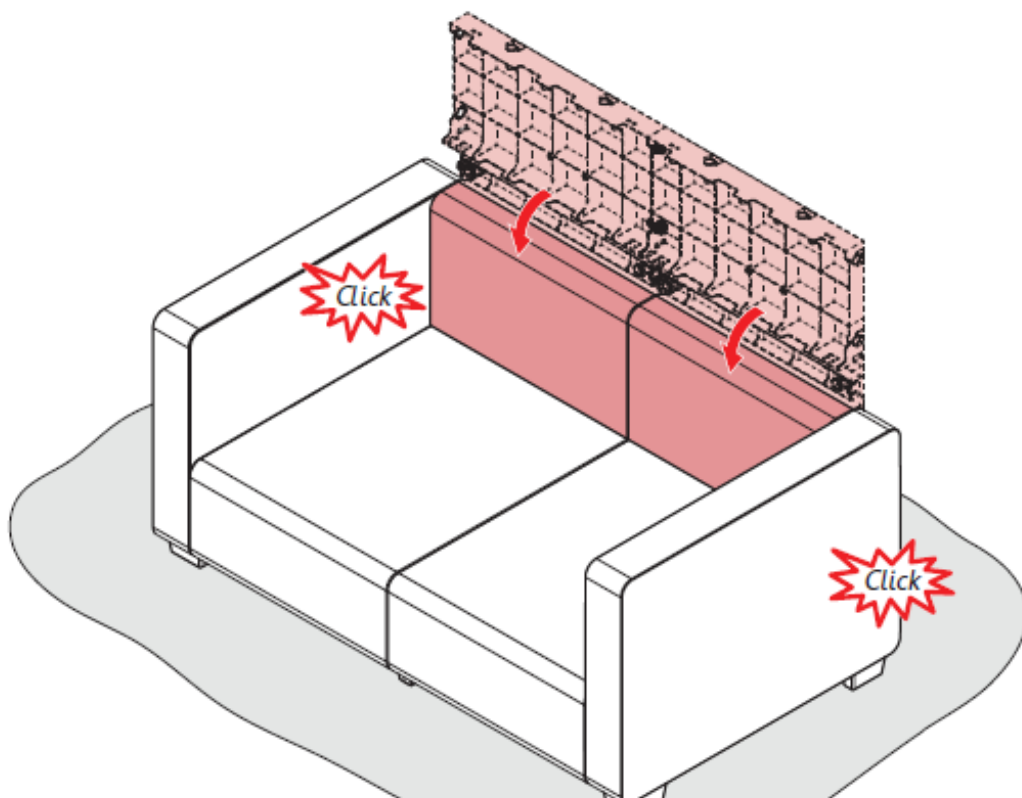

11

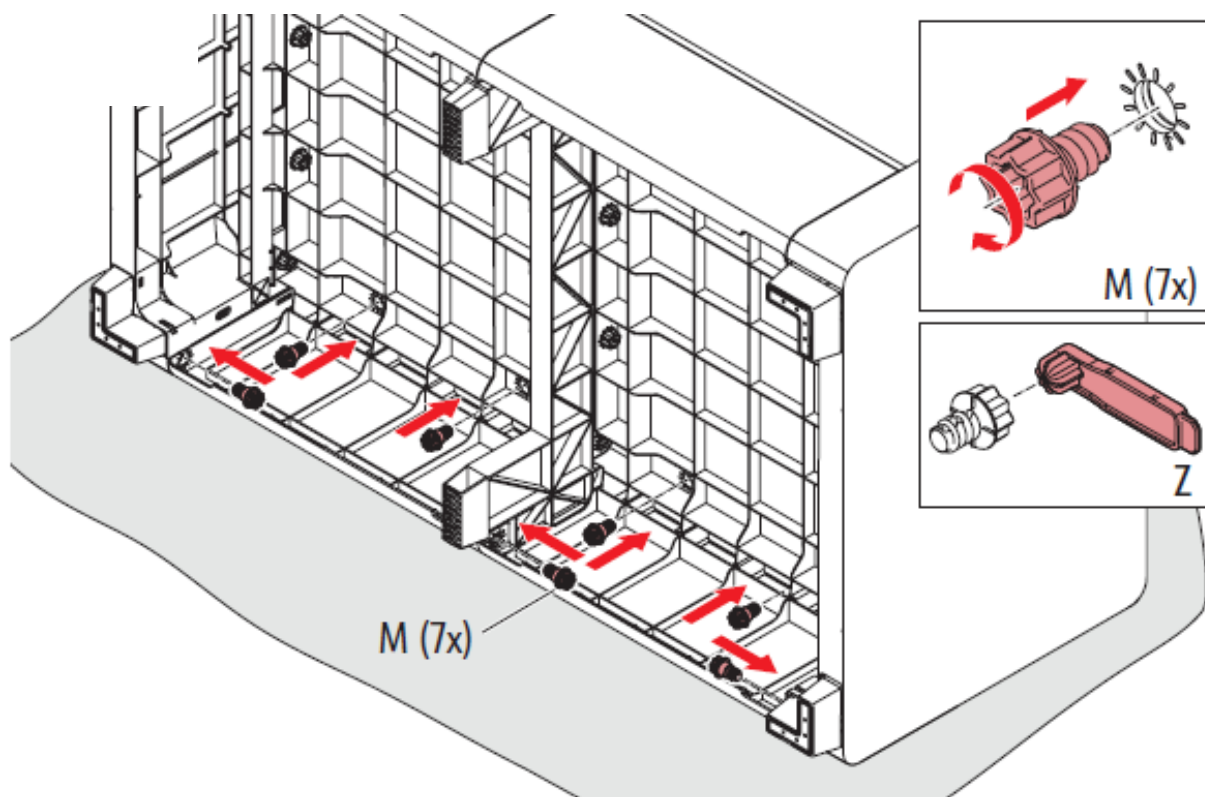

12

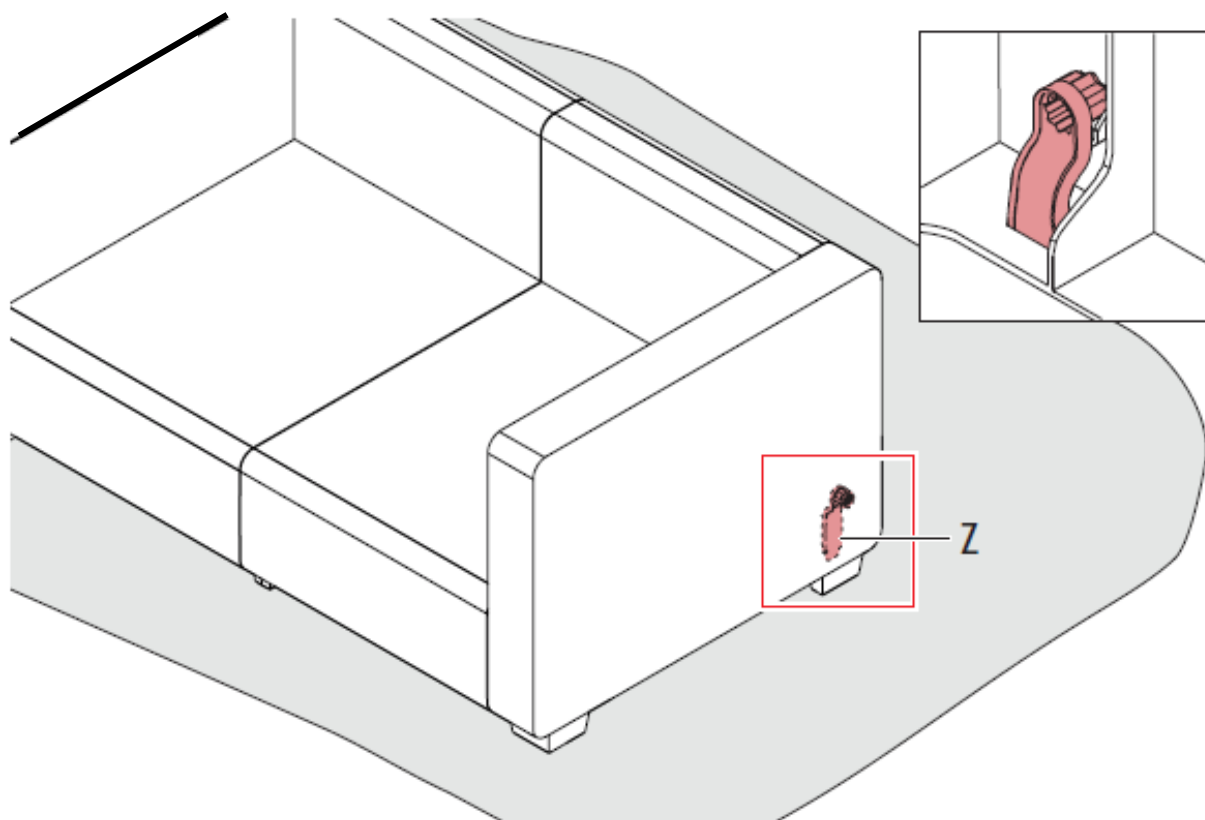

13

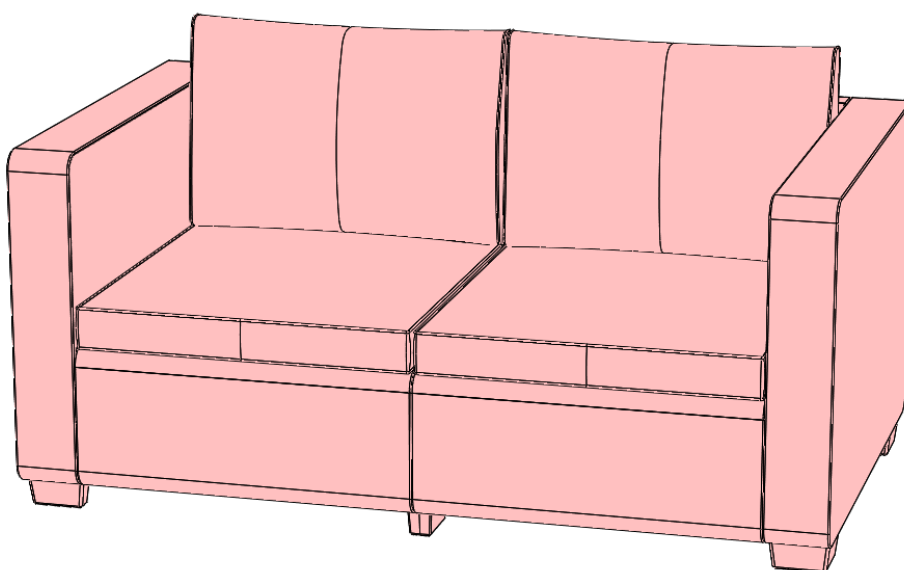
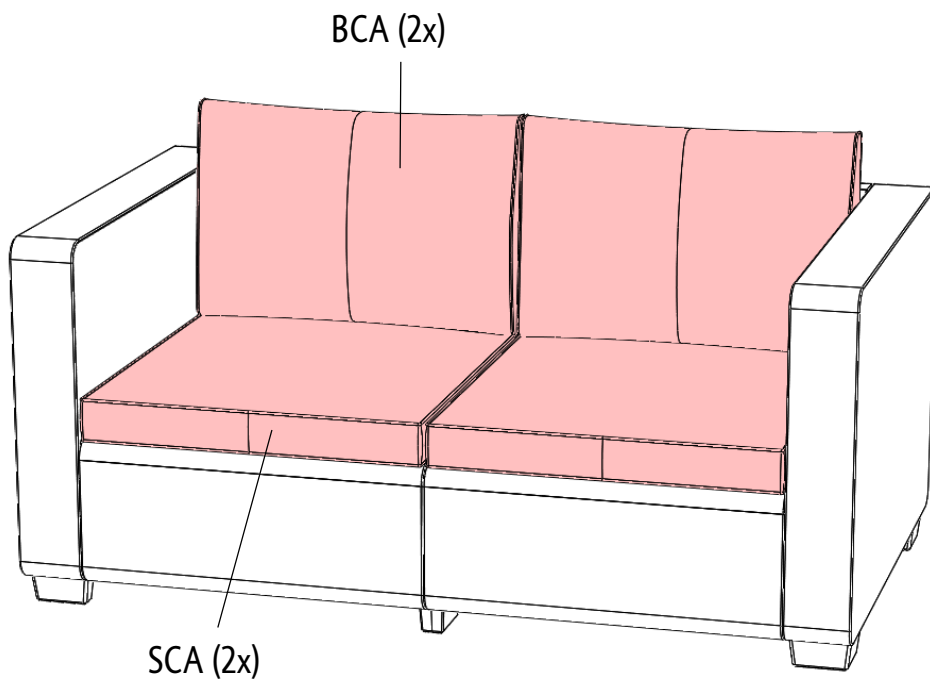

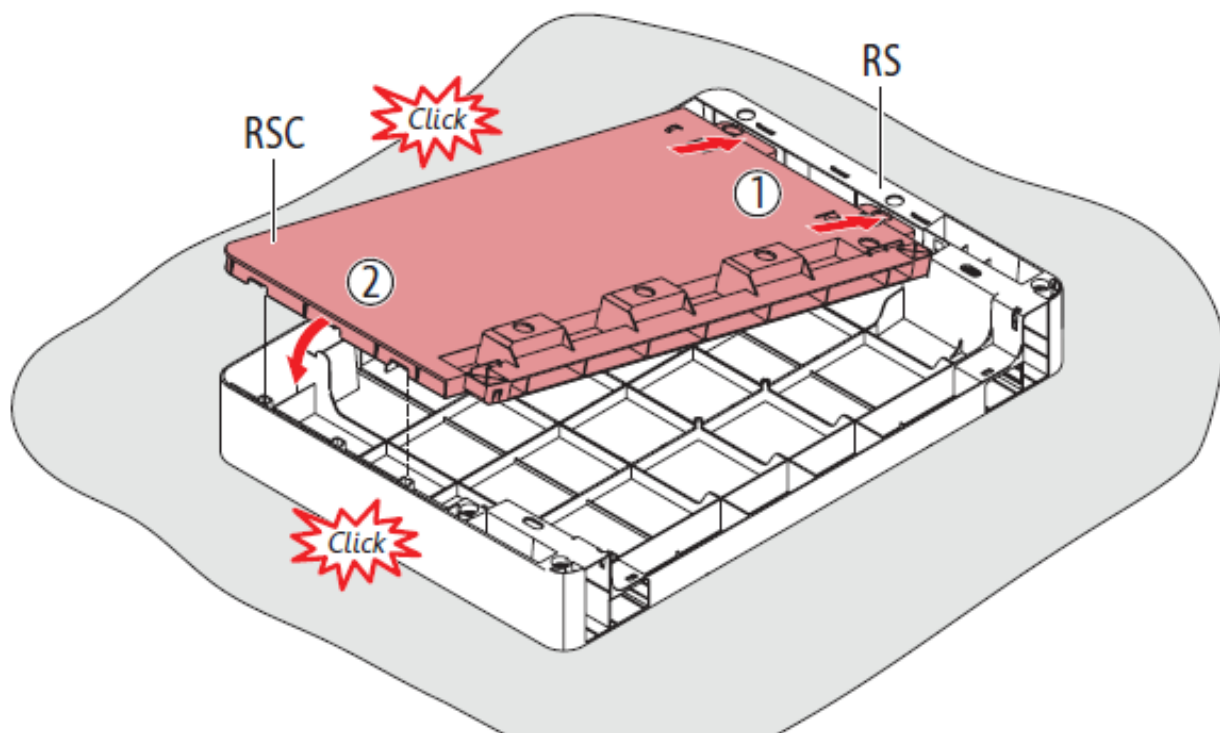

15

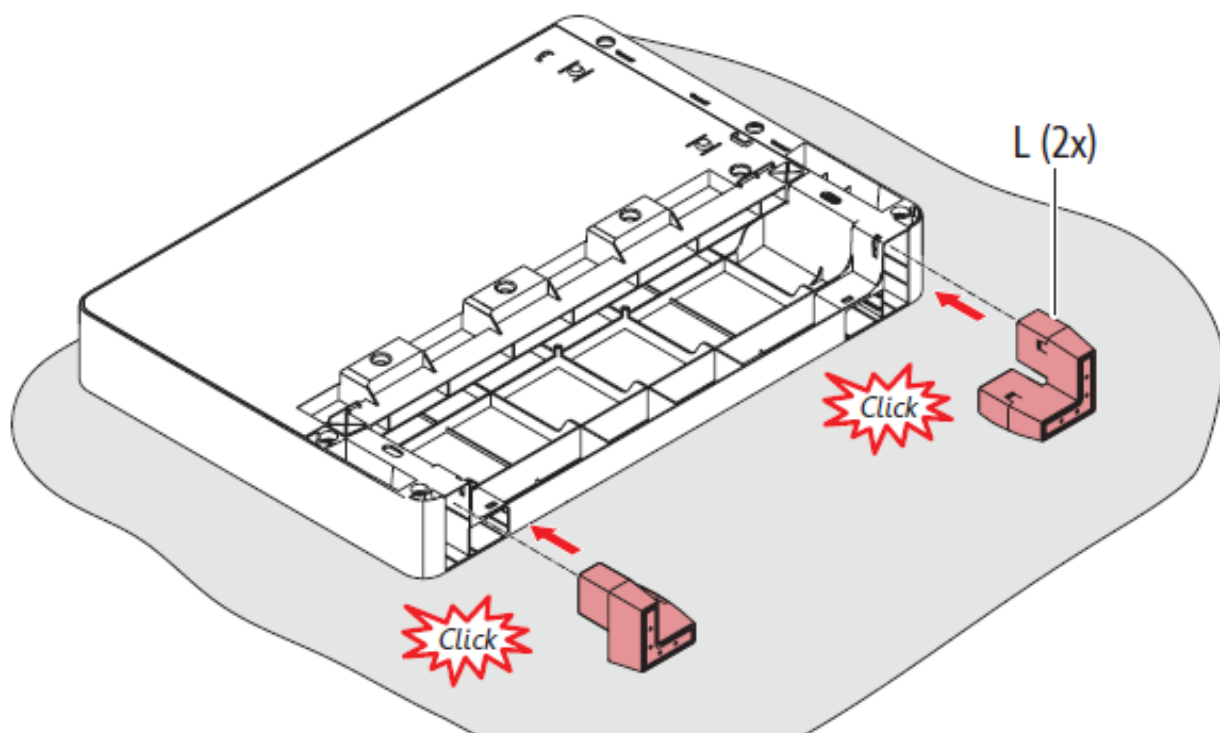

16



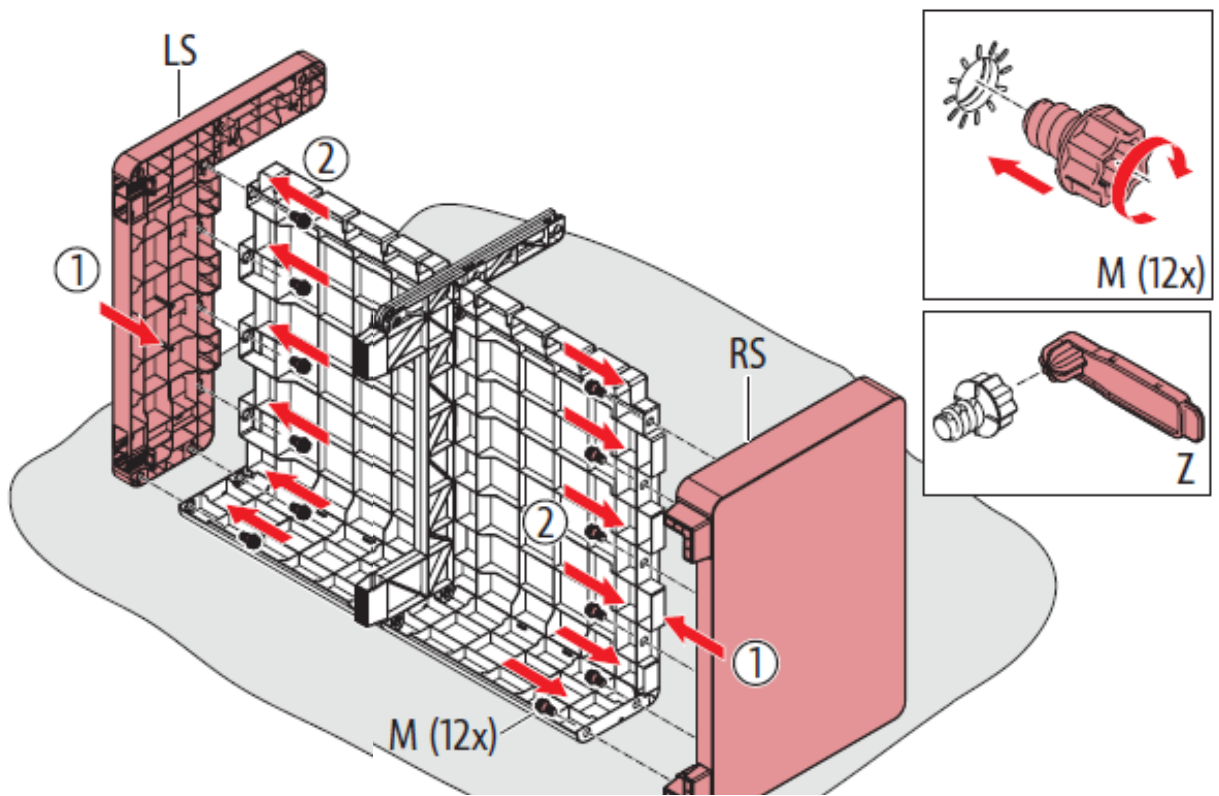

17

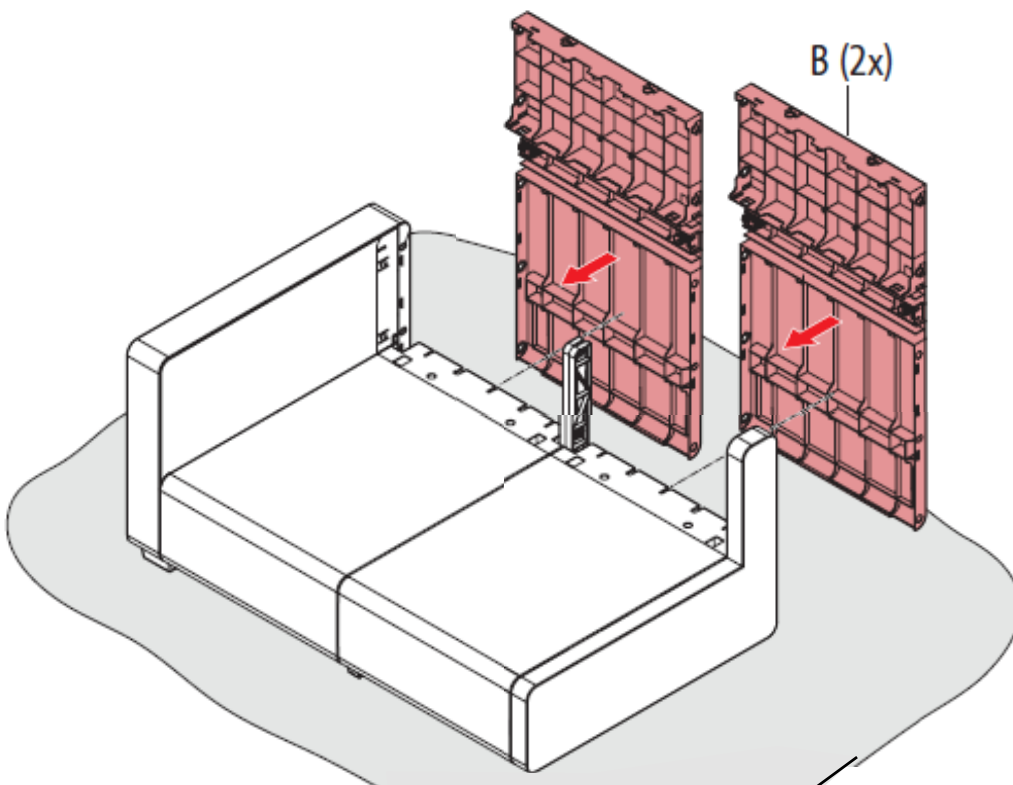

18



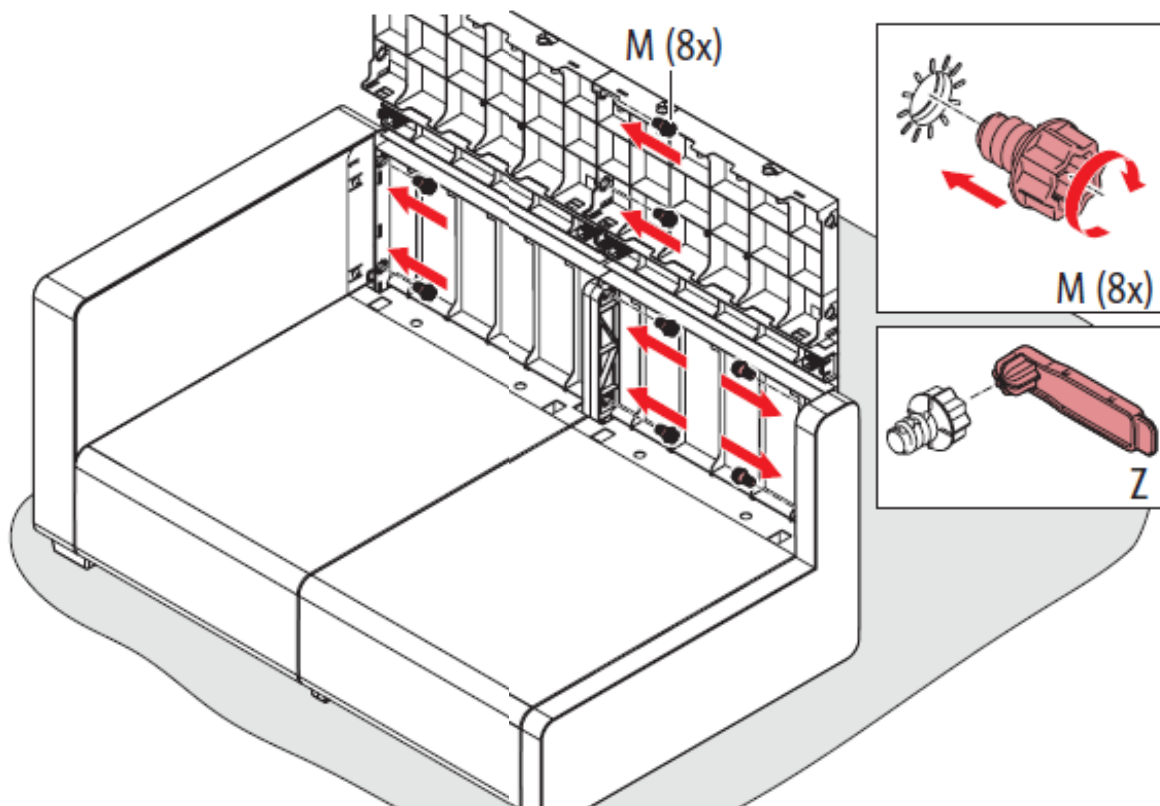

19

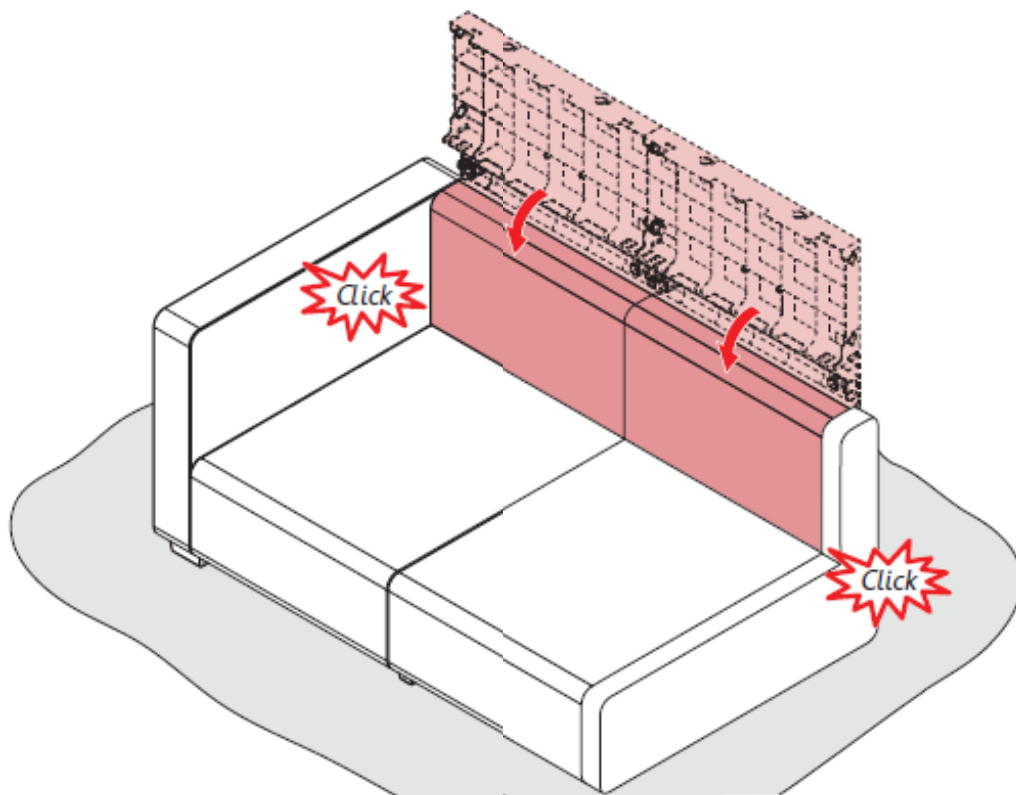

20



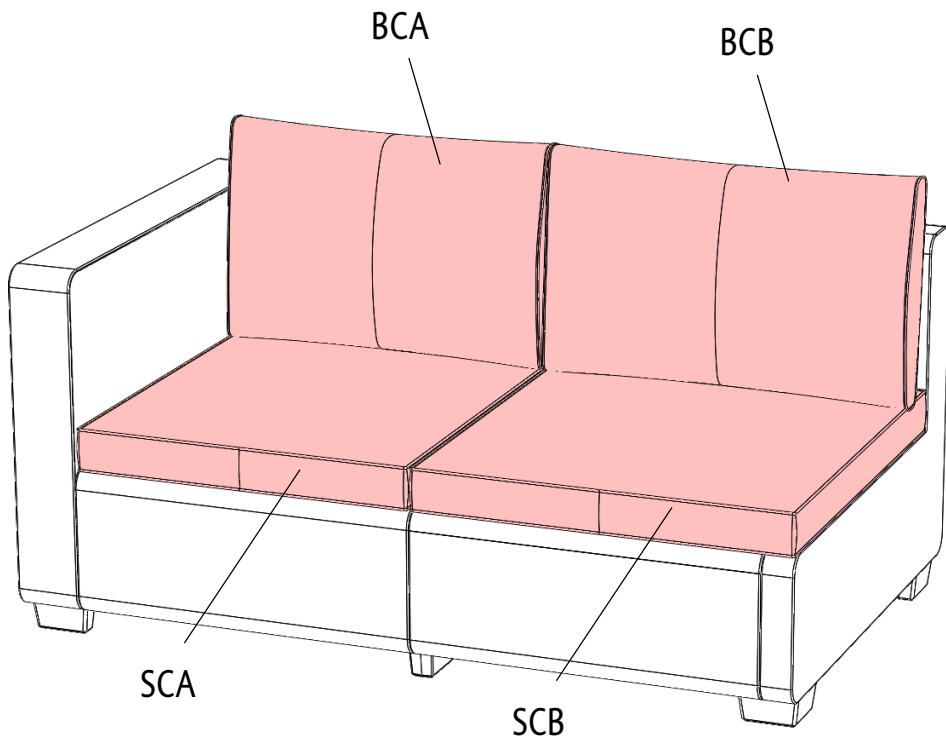

---

23

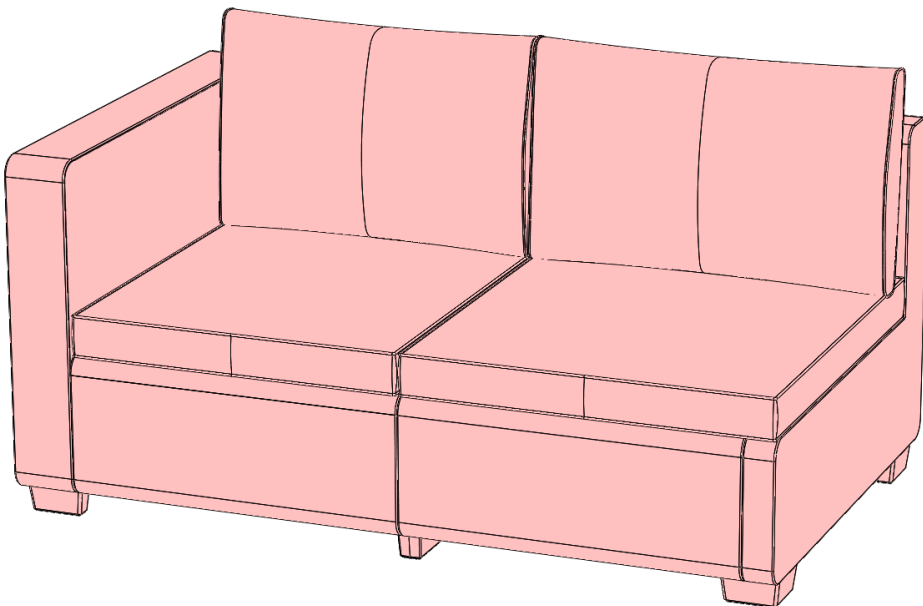

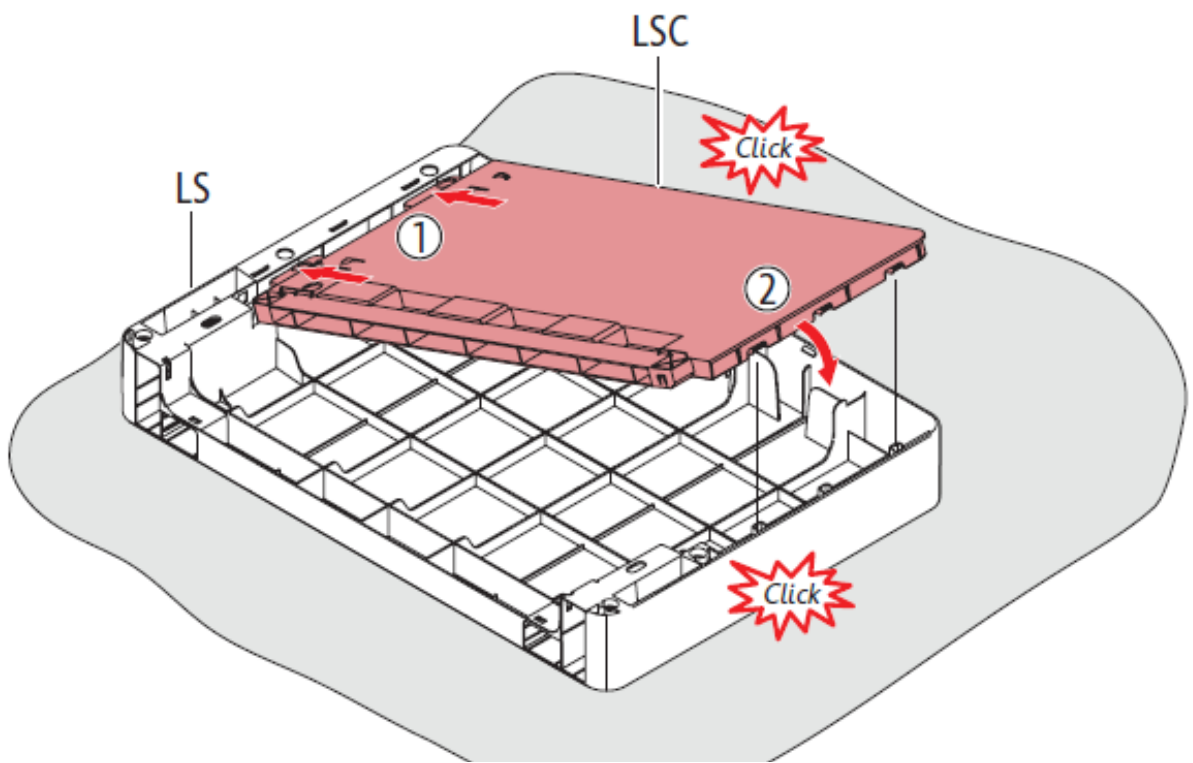

24

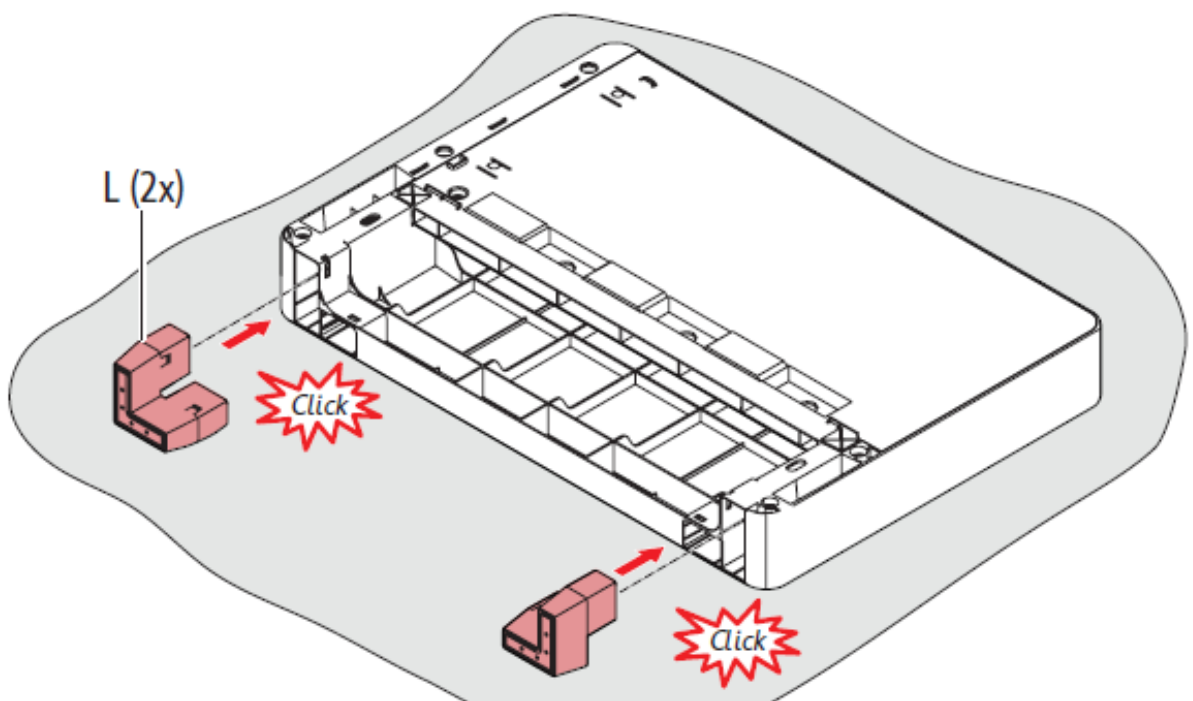

25

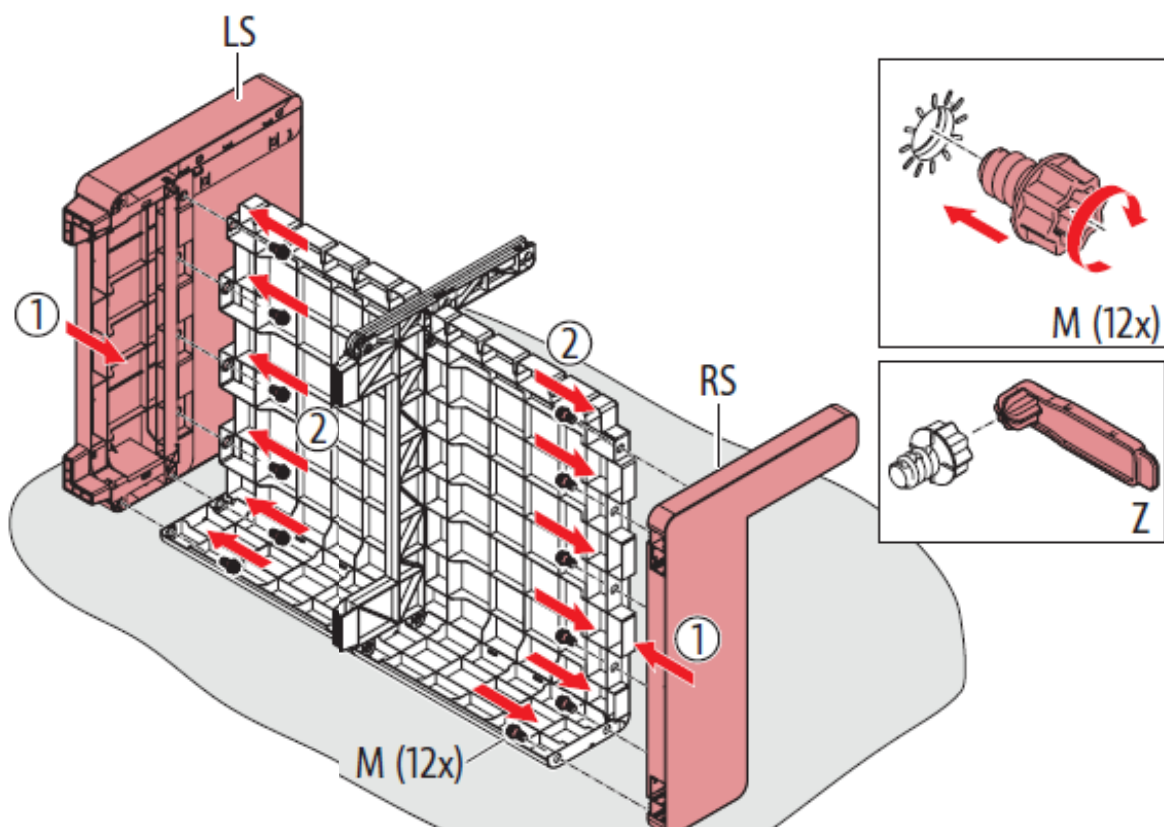

26

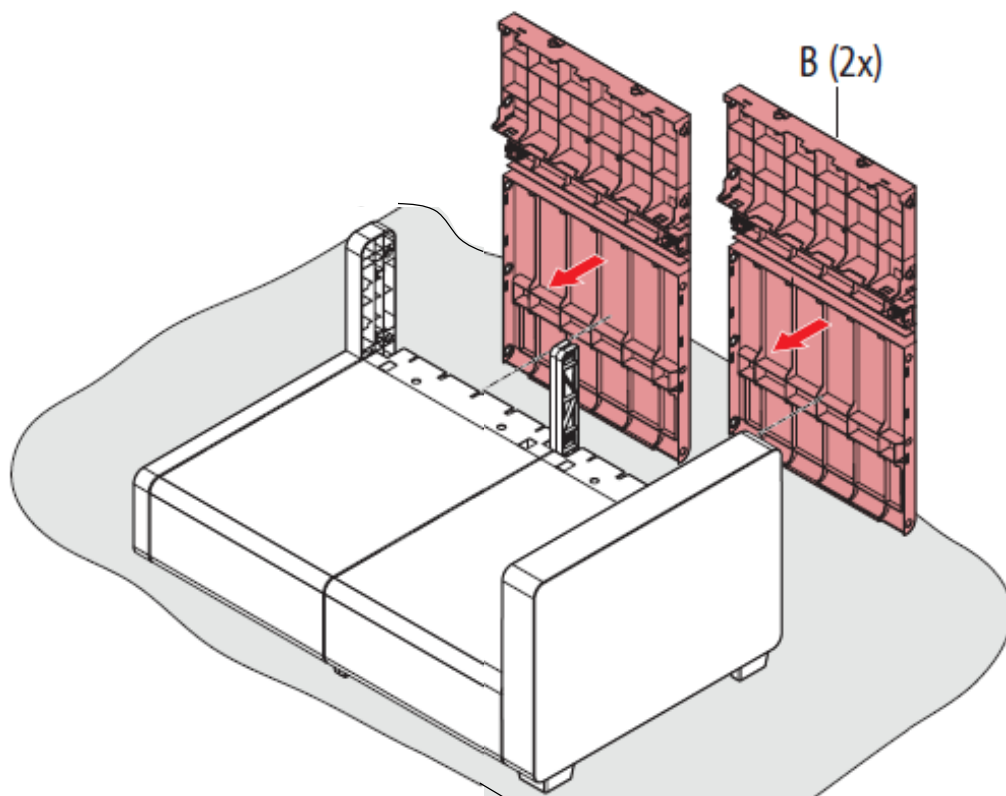

27

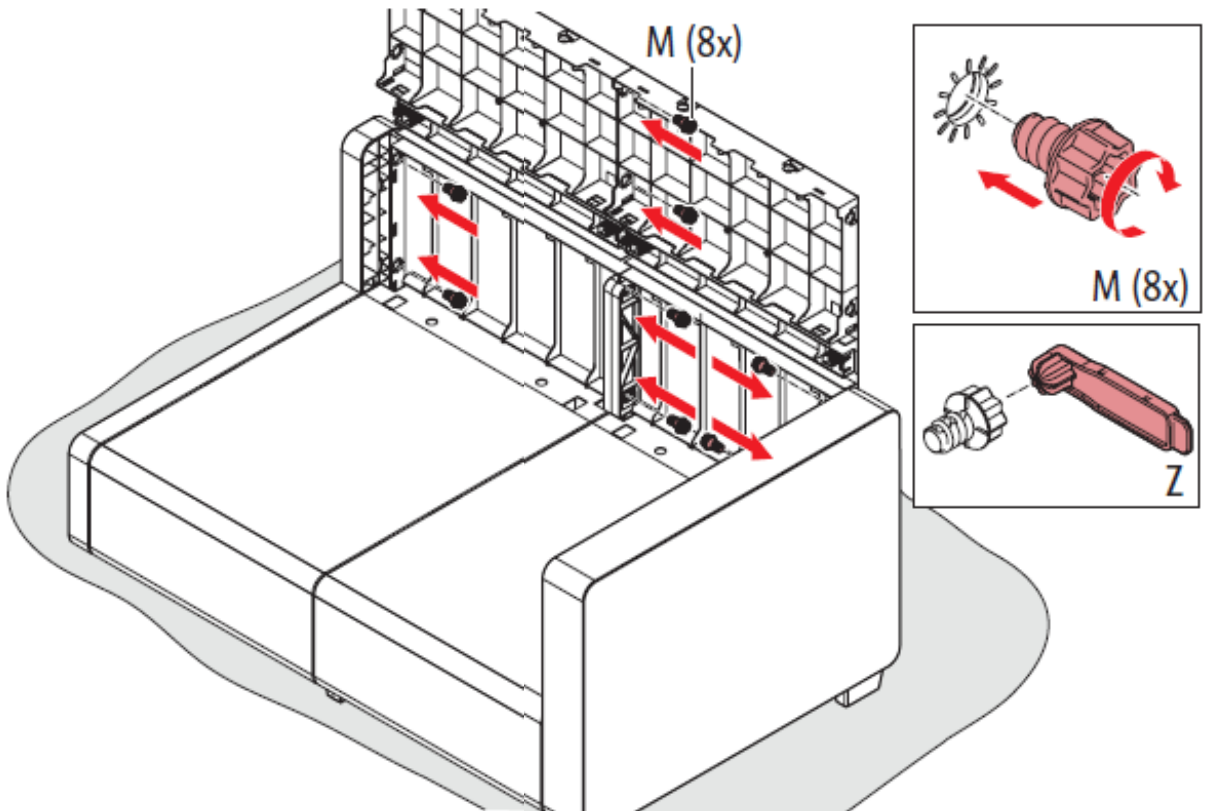

28

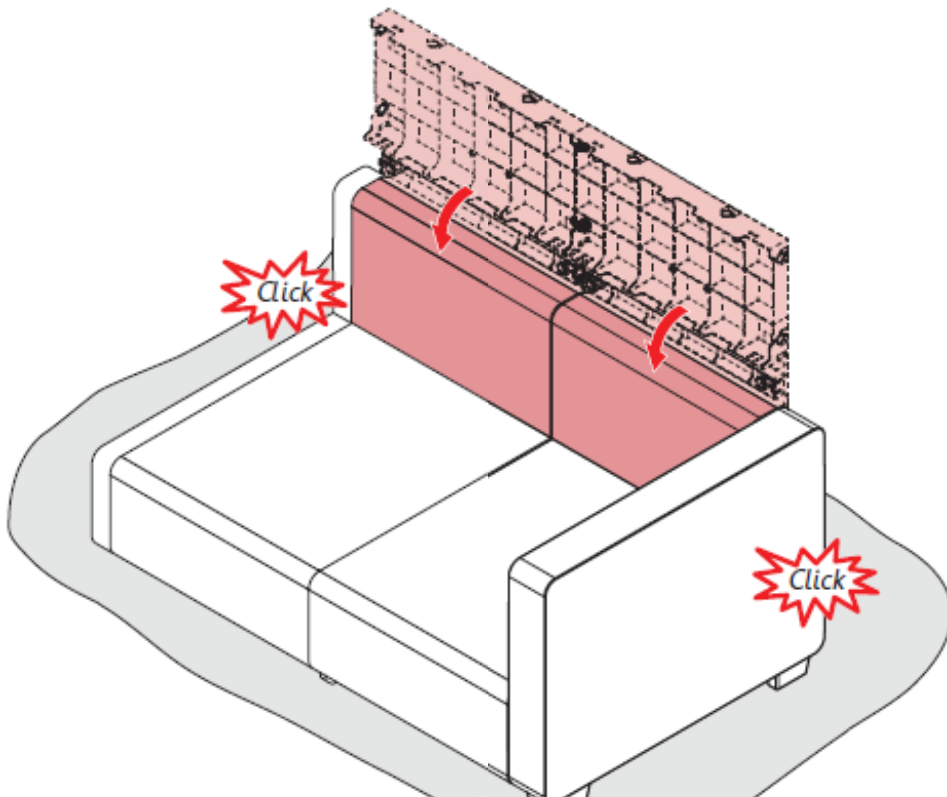

29



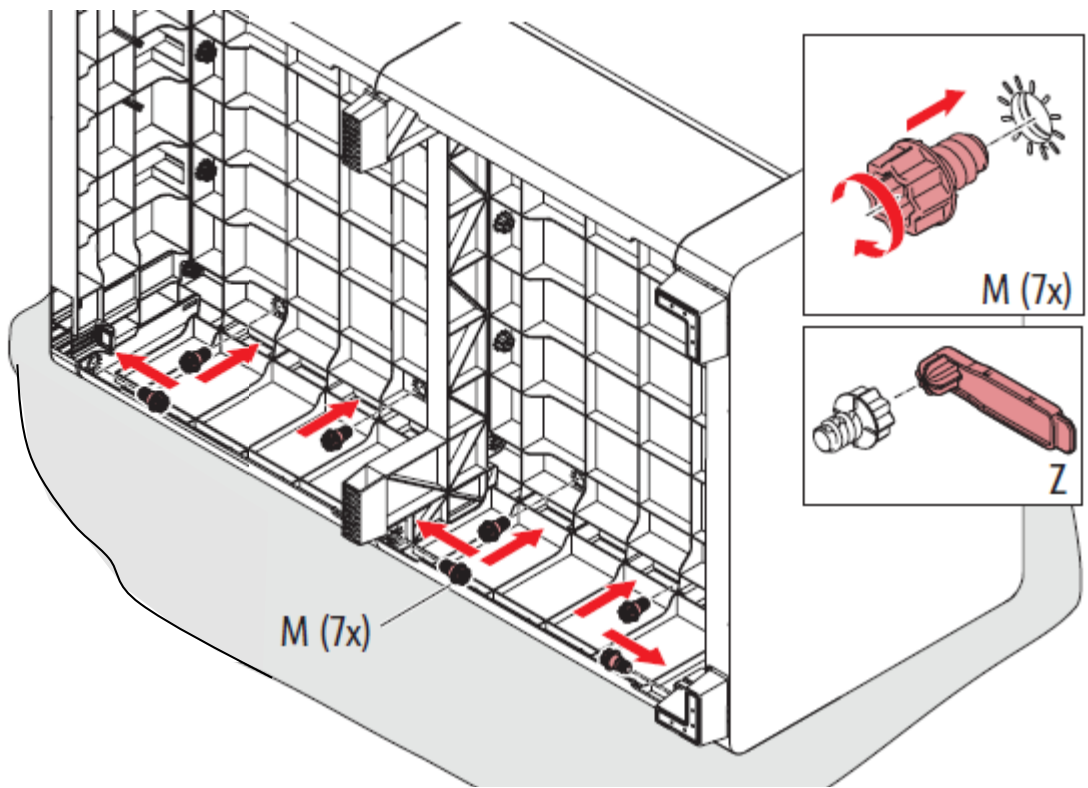

30

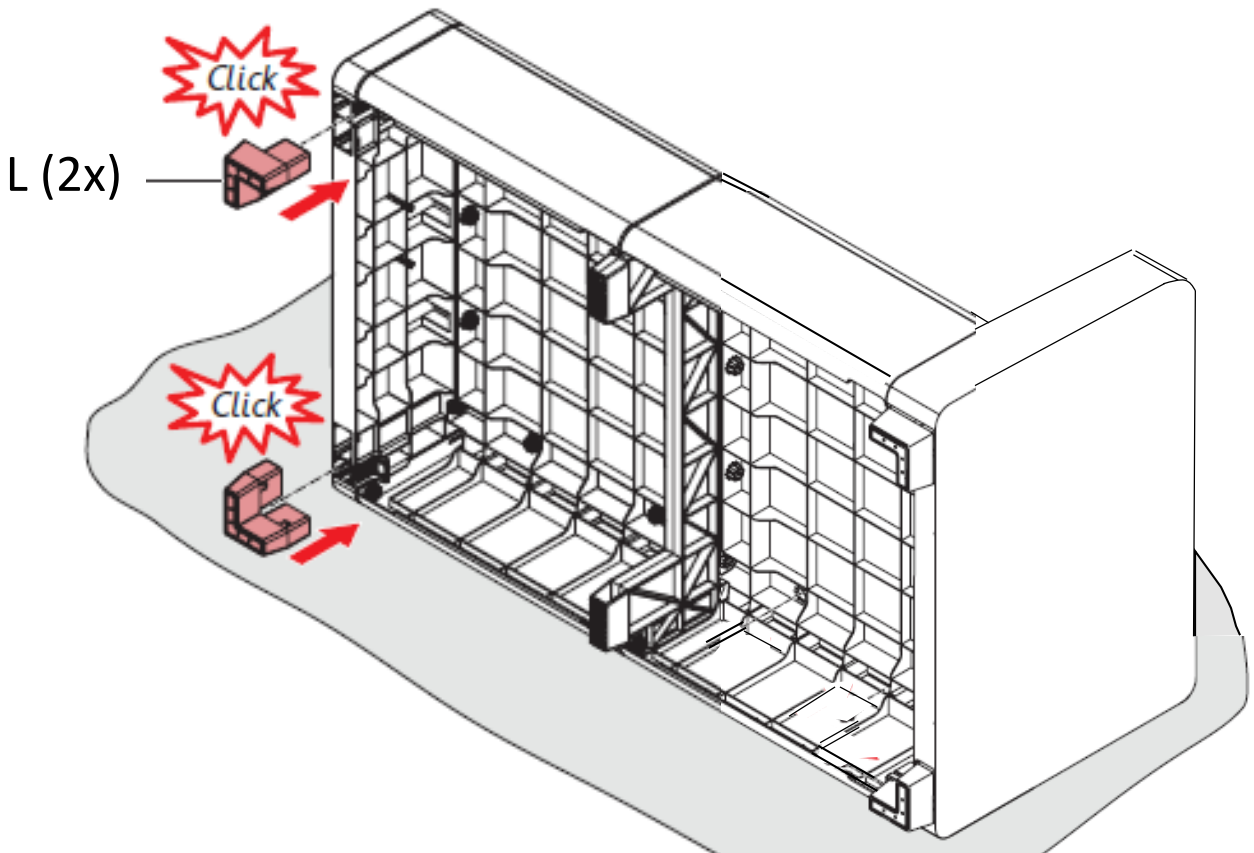

31



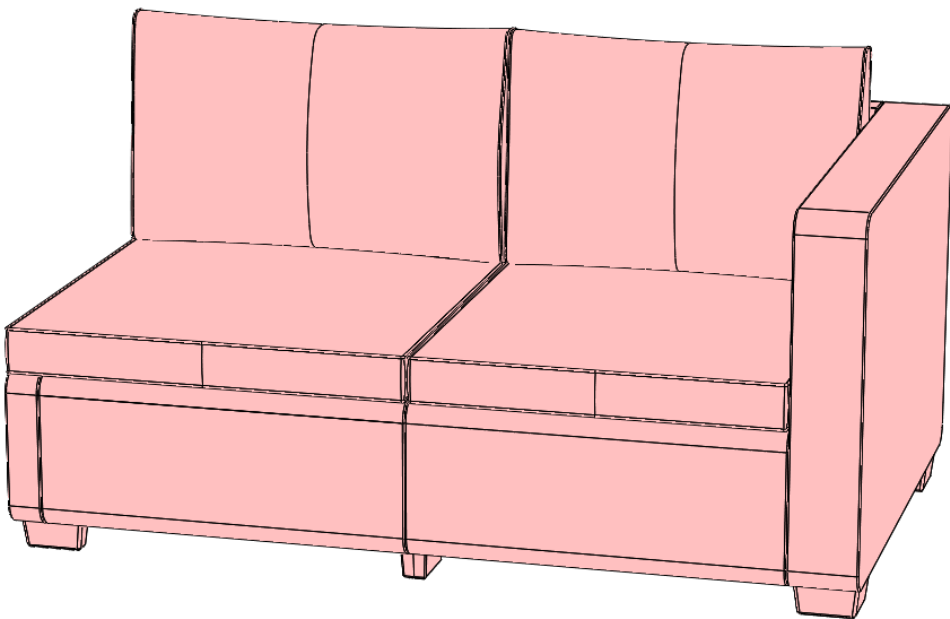
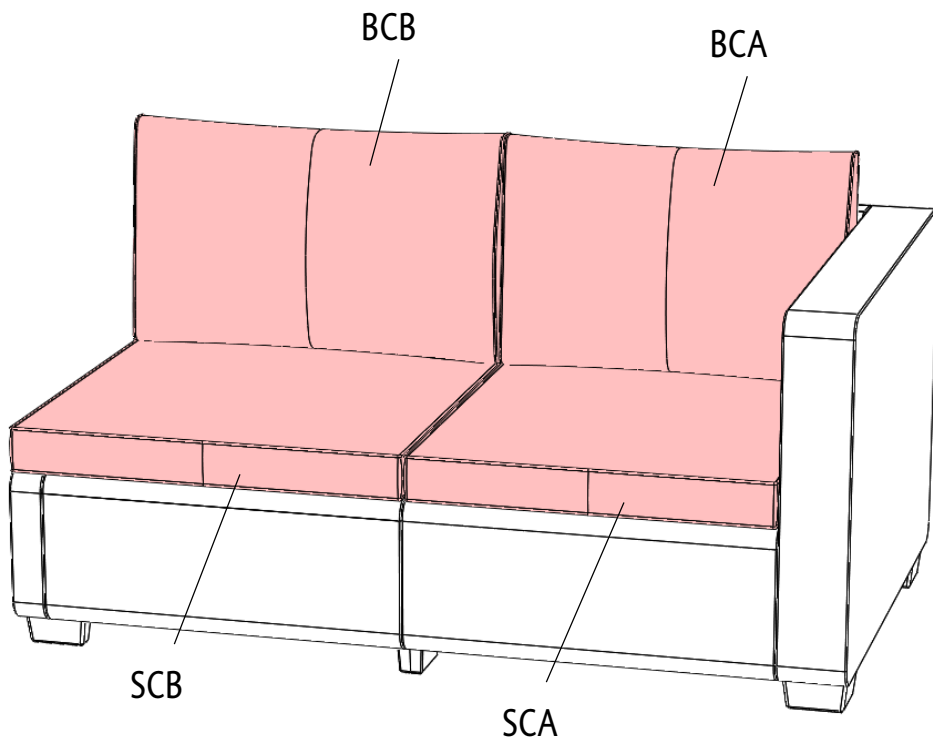

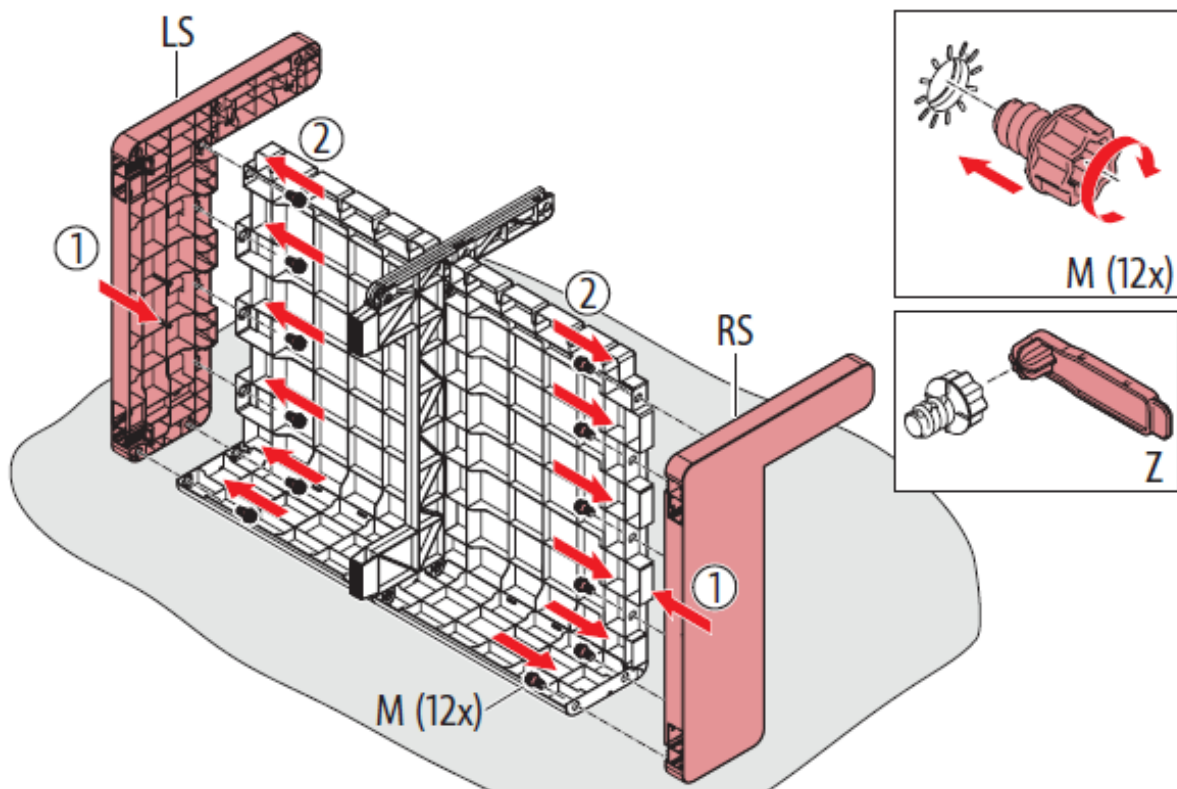

33

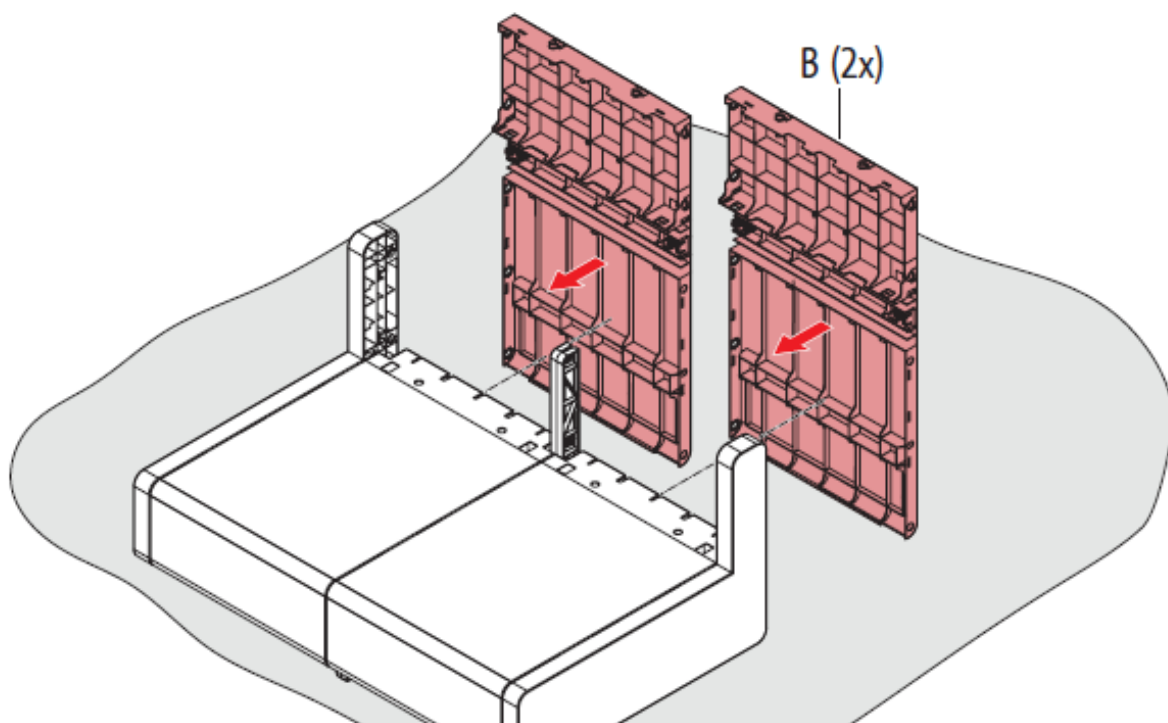

34

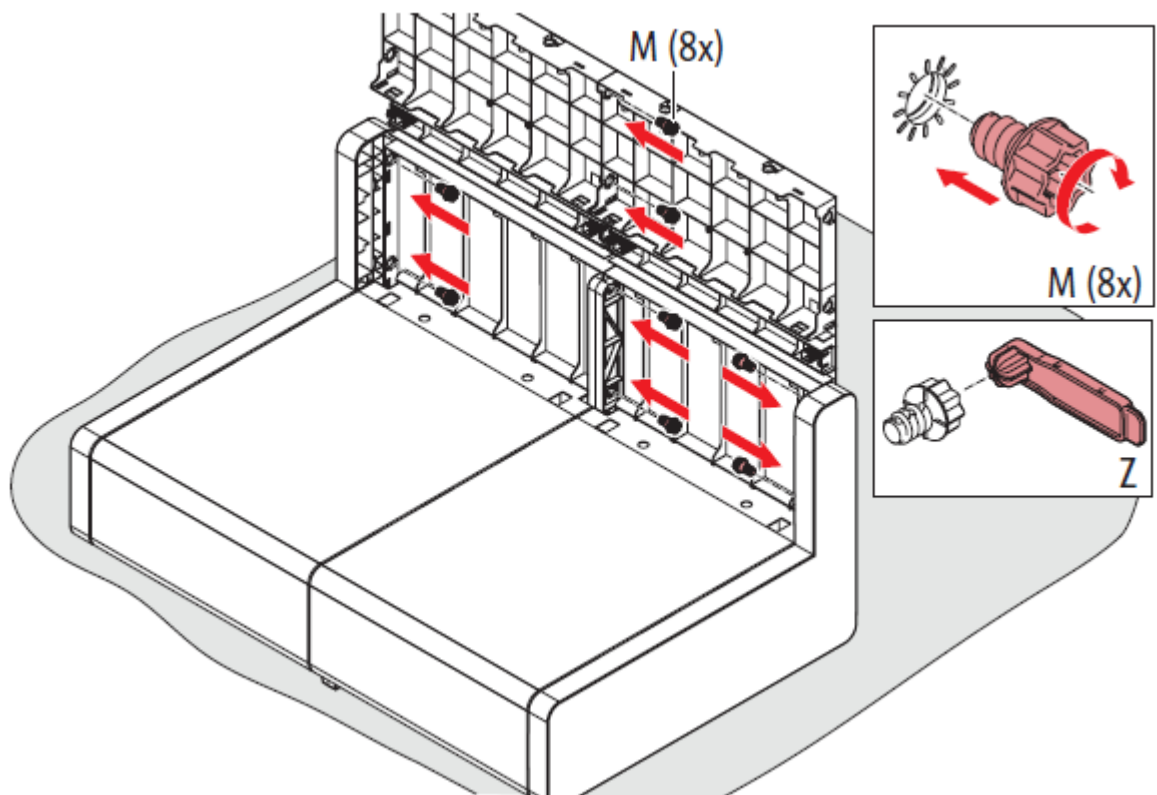

35

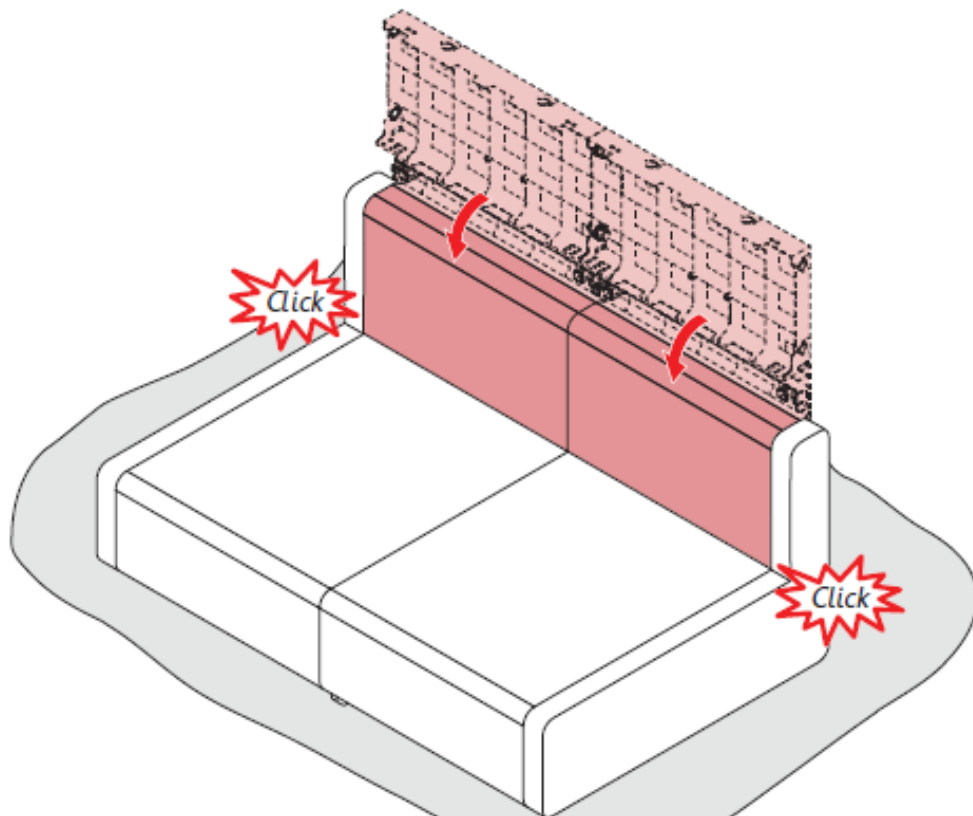

36

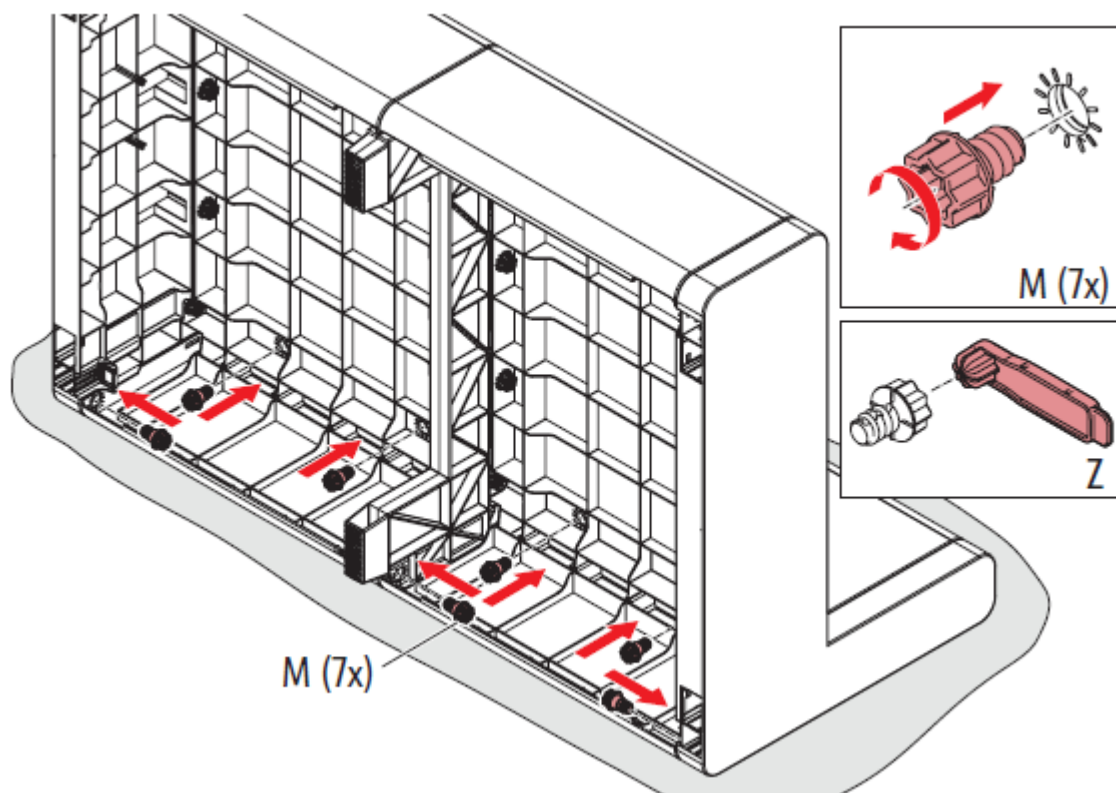

37

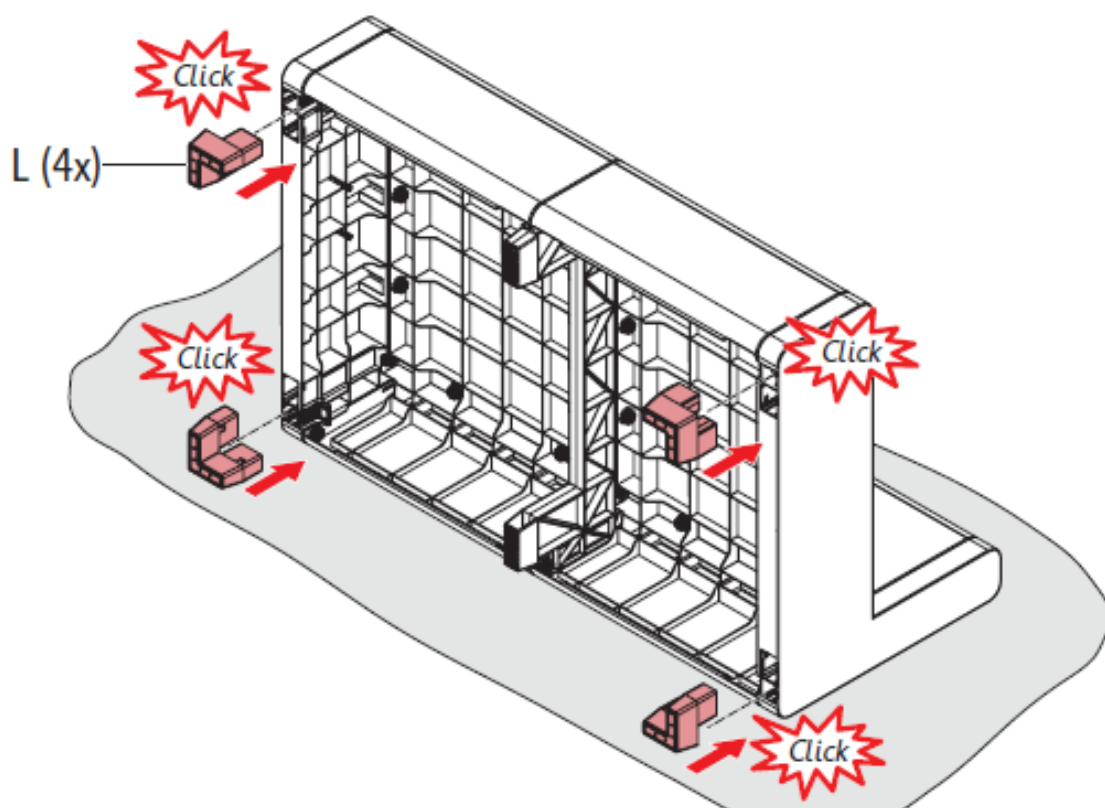

38

